

## Phase Control SCR TO-220AB FULL-PAK, 16 A

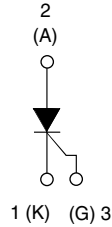

TO-220AB FULL-PAK



### DESCRIPTION/FEATURES

The 16TTS..FP High Voltage Series of silicon controlled rectifiers are specifically designed for medium power switching and phase control applications. The glass passivation technology used has reliable operation up to 125 °C junction temperature.

Typical applications are in input rectification (soft start) and these products are designed to be used with Vishay HPP input diodes, switches and output rectifiers which are available in identical package outlines.

Fully isolated package ( $V_{INS} = 2500 V_{RMS}$ ) is UL E78996 approved 

This product has been designed and qualified for industrial level.

### PRODUCT SUMMARY

$V_T$ at 10 A	1.4 V
$I_{TSM}$	200 A
$V_{RRM}$	800/1200 V

### OUTPUT CURRENT IN TYPICAL APPLICATIONS

APPLICATIONS	SINGLE-PHASE BRIDGE	THREE-PHASE BRIDGE	UNITS
Capacitive input filter $T_A = 55^\circ C$ , $T_J = 125^\circ C$ , common heatsink of $1^\circ C/W$	13.5	17	A

### MAJOR RATINGS AND CHARACTERISTICS

PARAMETER	TEST CONDITIONS	VALUES	UNITS
$I_{T(AV)}$	Sinusoidal waveform	10	A
$I_{RMS}$		16	
$V_{DRM}/V_{RRM}$		800/1200	V
$I_{TSM}$		200	A
$V_T$	10 A, $T_J = 25^\circ C$	1.4	V
dV/dt		500	V/ $\mu s$
dI/dt		150	A/ $\mu s$
$T_J$	Range	- 40 to 125	$^\circ C$

### VOLTAGE RATINGS

PART NUMBER	$V_{RRM}$ , MAXIMUM PEAK REVERSE VOLTAGE V	$V_{DRM}$ , MAXIMUM PEAK DIRECT VOLTAGE V	$I_{RRM}/I_{DRM}$ AT $125^\circ C$ mA
16TTS08FP	800	800	10
16TTS12FP	1200	1200	

# 16TTS..FP High Voltage Series



Vishay High Power Products Phase Control SCR  
TO-220AB FULL-PAK, 16 A

ABSOLUTE MAXIMUM RATINGS						
PARAMETER	SYMBOL	TEST CONDITIONS	VALUES		UNITS	
			TYP.	MAX.		
Maximum average on-state current	$I_{T(AV)}$	$T_c = 95\text{ }^\circ\text{C}$ , 180° conduction, half sine wave	10		A	
Maximum RMS on-state current	$I_{RMS}$		16			
Maximum peak, one-cycle, non-repetitive surge current	$I_{TSM}$	10 ms sine pulse, rated $V_{RRM}$ applied	170			
		10 ms sine pulse, no voltage reapplied	200			
Maximum $I^2t$ for fusing	$I^2t$	10 ms sine pulse, rated $V_{RRM}$ applied	144		A <sup>2</sup> s	
		10 ms sine pulse, no voltage reapplied	200			
Maximum $I^2\sqrt{t}$ for fusing	$I^2\sqrt{t}$	$t = 0.1$ to 10 ms, no voltage reapplied	2000		A <sup>2</sup> √s	
Maximum on-state voltage drop	$V_{TM}$	10 A, $T_J = 25\text{ }^\circ\text{C}$	1.4		V	
On-state slope resistance	$r_t$	$T_J = 125\text{ }^\circ\text{C}$	24.0		mΩ	
Threshold voltage	$V_{T(TO)}$		1.1		V	
Maximum reverse and direct leakage current	$I_{RM}/I_{DM}$	$V_R = \text{Rated } V_{RRM}/V_{DRM}$	$T_J = 25\text{ }^\circ\text{C}$	0.5		mA
			$T_J = 125\text{ }^\circ\text{C}$	10		
Holding current	$I_H$	Anode supply = 6 V, resistive load, initial $I_T = 1$ A 16TTS08FP, 16TTS12FP	-	100		
Maximum latching current	$I_L$	Anode supply = 6 V, resistive load	200			
Maximum rate of rise of off-state voltage	$dV/dt$		500		V/μs	
Maximum rate of rise of turned-on current	$dI/dt$		150		A/μs	

TRIGGERING					
PARAMETER	SYMBOL	TEST CONDITIONS	VALUES		UNITS
Maximum peak gate power	$P_{GM}$		8.0		W
Maximum average gate power	$P_{G(AV)}$		2.0		
Maximum peak positive gate current	+ $I_{GM}$		1.5		A
Maximum peak negative gate voltage	- $V_{GM}$		10		V
Maximum required DC gate current to trigger	$I_{GT}$	Anode supply = 6 V, resistive load, $T_J = -10\text{ }^\circ\text{C}$	90		mA
		Anode supply = 6 V, resistive load, $T_J = 25\text{ }^\circ\text{C}$	60		
		Anode supply = 6 V, resistive load, $T_J = 125\text{ }^\circ\text{C}$	35		
Maximum required DC gate voltage to trigger	$V_{GT}$	Anode supply = 6 V, resistive load, $T_J = -10\text{ }^\circ\text{C}$	3.0		V
		Anode supply = 6 V, resistive load, $T_J = 25\text{ }^\circ\text{C}$	2.0		
		Anode supply = 6 V, resistive load, $T_J = 125\text{ }^\circ\text{C}$	1.0		
Maximum DC gate voltage not to trigger	$V_{GD}$	$T_J = 125\text{ }^\circ\text{C}$ , $V_{DRM} = \text{Rated value}$	0.2		
Maximum DC gate current not to trigger	$I_{GD}$		2.0		mA

SWITCHING					
PARAMETER	SYMBOL	TEST CONDITIONS	VALUES		UNITS
Typical turn-on time	$t_{gt}$	$T_J = 25\text{ }^\circ\text{C}$	0.9		μs
Typical reverse recovery time	$t_{rr}$	$T_J = 125\text{ }^\circ\text{C}$	4		
Typical turn-off time	$t_q$		110		



# 16TTS..FP High Voltage Series

Phase Control SCR      Vishay High Power Products  
TO-220AB FULL-PAK, 16 A

<b>THERMAL AND MECHANICAL SPECIFICATIONS</b>				
PARAMETER	SYMBOL	TEST CONDITIONS	VALUES	UNITS
Maximum junction and storage temperature range	$T_J, T_{Stg}$		- 40 to 125	°C
Maximum thermal resistance, junction to case	$R_{thJC}$	DC operation	1.5	°C/W
Maximum thermal resistance, junction to ambient	$R_{thJA}$		62	
Typical thermal resistance, case to heatsink	$R_{thCS}$	Mounting surface, smooth and greased	1.5	
Approximate weight			2	g
			0.07	oz.
Mounting torque	minimum		6 (5)	kgf · cm
	maximum		12 (10)	(lbf · in)
Marking device		Case style TO-220AB FULL-PAK (94/V0)	16TTS08FP	
			16TTS12FP	

# 16TTS..FP High Voltage Series



Vishay High Power Products

Phase Control SCR  
TO-220AB FULL-PAK, 16 A

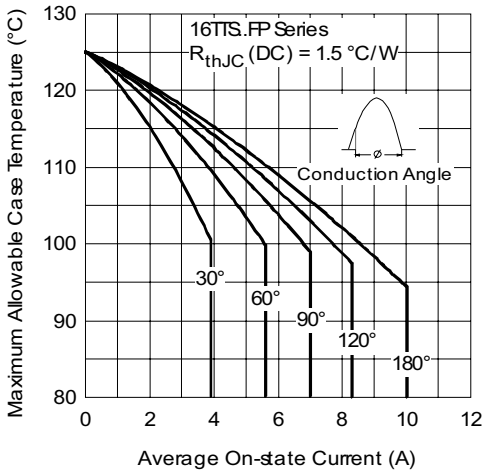

Fig. 1 - Current Rating Characteristics

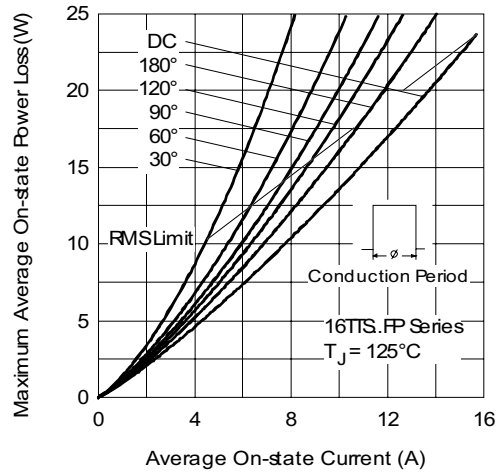

Fig. 4 - On-State Power Loss Characteristics

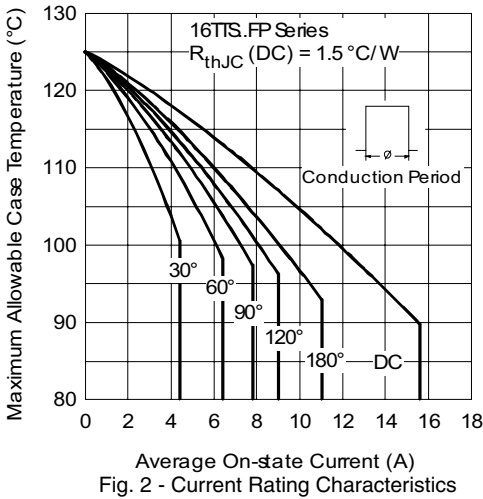

Fig. 2 - Current Rating Characteristics

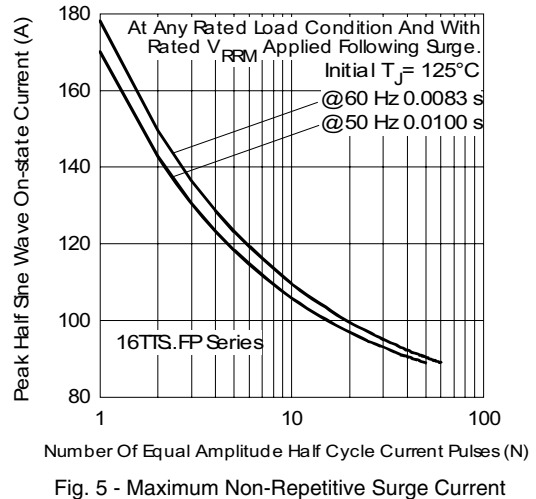

Fig. 5 - Maximum Non-Repetitive Surge Current

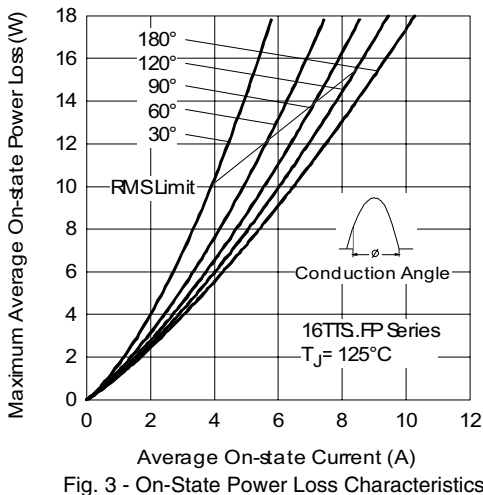

Fig. 3 - On-State Power Loss Characteristics

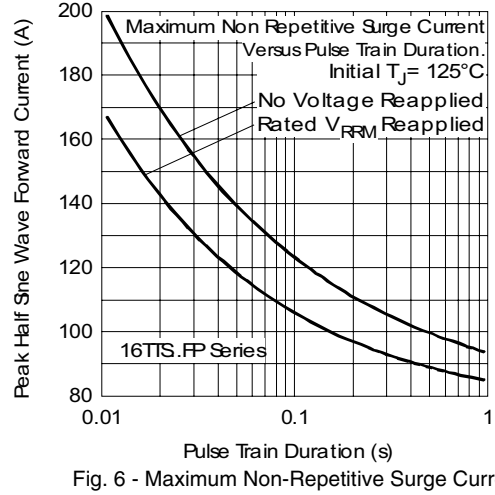

Fig. 6 - Maximum Non-Repetitive Surge Current



# 16TTS..FP High Voltage Series

Phase Control SCR      Vishay High Power Products  
 TO-220AB FULL-PAK, 16 A

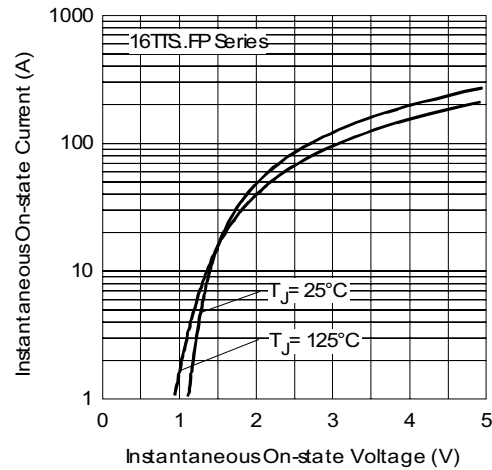

Fig. 7 - On-State Voltage Drop Characteristics

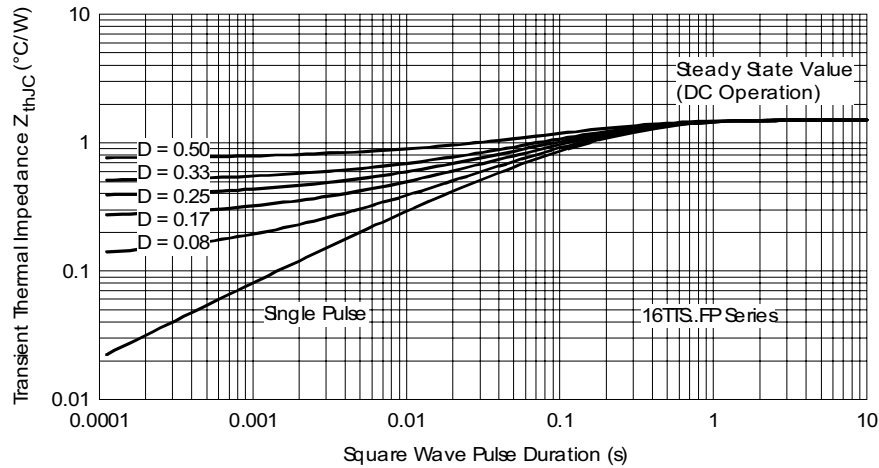

Fig. 8 - Thermal impedance  $Z_{thJC}$  Characteristics

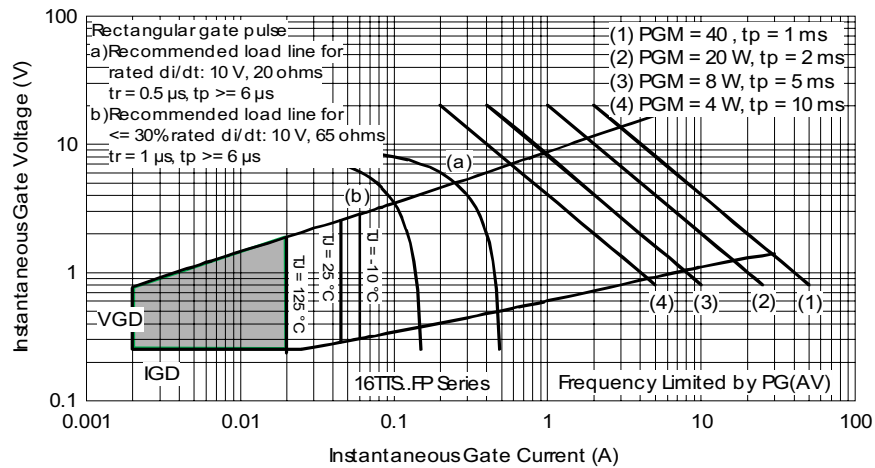

Fig. 9 - Gate Characteristics

# 16TTS..FP High Voltage Series



Vishay High Power Products Phase Control SCR  
TO-220AB FULL-PAK, 16 A

## ORDERING INFORMATION TABLE

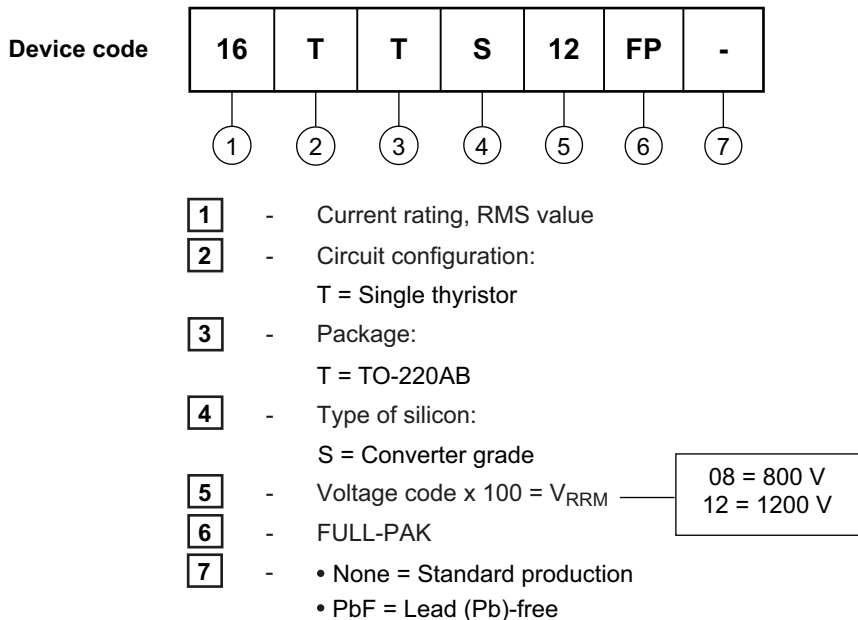

Note: For higher voltage up to 1600 V contact factory

LINKS TO RELATED DOCUMENTS	
Dimensions	<a href="http://www.vishay.com/doc?95072">http://www.vishay.com/doc?95072</a>
Part marking information	<a href="http://www.vishay.com/doc?95069">http://www.vishay.com/doc?95069</a>



## Disclaimer

All product specifications and data are subject to change without notice.

Vishay Intertechnology, Inc., its affiliates, agents, and employees, and all persons acting on its or their behalf (collectively, "Vishay"), disclaim any and all liability for any errors, inaccuracies or incompleteness contained herein or in any other disclosure relating to any product.

Vishay disclaims any and all liability arising out of the use or application of any product described herein or of any information provided herein to the maximum extent permitted by law. The product specifications do not expand or otherwise modify Vishay's terms and conditions of purchase, including but not limited to the warranty expressed therein, which apply to these products.

No license, express or implied, by estoppel or otherwise, to any intellectual property rights is granted by this document or by any conduct of Vishay.

The products shown herein are not designed for use in medical, life-saving, or life-sustaining applications unless otherwise expressly indicated. Customers using or selling Vishay products not expressly indicated for use in such applications do so entirely at their own risk and agree to fully indemnify Vishay for any damages arising or resulting from such use or sale. Please contact authorized Vishay personnel to obtain written terms and conditions regarding products designed for such applications.

Product names and markings noted herein may be trademarks of their respective owners.